

RT80 / RT80M

Retrofit Torch for Powermax1100

Operator Manual
804550 – Revision 1

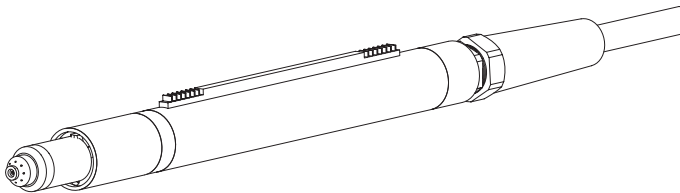
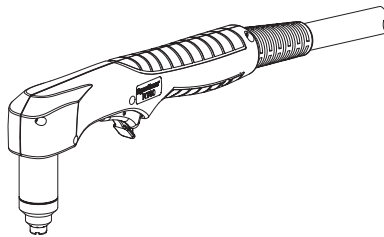

Hypertherm[®]

*The world leader in
plasma cutting technology™*

RT80 / RT80M

Operator Manual

(P/N 804550)

Revision 1 – June, 2003

**Hypertherm, Inc.
Hanover, NH USA
www.hypertherm.com**

**© Copyright 2003 Hypertherm, Inc.
All Rights Reserved**

**Hypertherm and Powermax are trademarks of Hypertherm, Inc.
and may be registered in the United States and/or other countries.**

Hypertherm, Inc.

Etna Road, P.O. Box 5010
Hanover, NH 03755 USA
603-643-3441 Tel (Main Office)
603-643-5352 Fax (All Departments)
info@hypertherm.com (Main Office Email)
800-643-9878 Tel (Technical Service)
service@hypertherm.com (Technical Service Email)
800-737-2978 Tel (Customer Service)
customer.service@hypertherm.com (Customer Service Email)

Hypertherm Automation, LLC

5 Technology Drive, Suite 300
West Lebanon, NH 03755 USA
603-298-7970 Tel
603-298-7977 Fax

Hypertherm Plasmatechnik, GmbH

Technologiepark Hanau
Rodenbacher Chaussee 6
63457 Hanau-Wolfgang, Deutschland
49 6181 58 2100 Tel
49 6181 58 2134 Fax
49 6181 58 2123 (Technical Service)

Hypertherm (S) Pte Ltd.

No. 19 Kaki Bukit Road 2
K.B. Warehouse Complex
Singapore 417847, Republic of Singapore
65 6 841 2489 Tel
65 6 841 2490 Fax
65 6 841 2489 (Technical Service)

Hypertherm UK, Ltd.

9 Berkeley Court, Manor Park
Runcorn, Cheshire, England WA7 1TQ
44 1928 579 074 Tel
44 1928 579 604 Fax

France

15 Impasse des Rosiers
95610 Eragny, France
00 800 3324 9737 Tel
00 800 4973 7329 Fax

Hypertherm S.r.l.

Via Torino 2
20123 Milano, Italia
39 02 725 46 312 Tel
39 02 725 46 400 Fax
39 02 725 46 314 (Technical Service)

Hypertherm Europe B.V.

Vaartveld 9
4704 SE Roosendaal, Nederland
31 165 596907 Tel
31 165 596901 Fax
31 165 596908 Tel (Marketing)
31 165 596900 Tel (ETSO - Technical Service)
00 800 49 73 7843 Tel (ETSO - Technical Service)
toll-free in Europe

Japan

1952-14 Yata-Natsumegi
Mishima City, Shizuoka Pref.
411-0801 Japan
81 0 559 75 7387 Tel
81 0 559 75 7376 Fax

Hypertherm Brasil Ltda.

Rua Visconde de Santa Isabel, 20 - Sala 611
Vila Isabel, RJ
Brasil CEP 20560-120
55 21 2278 6162 Tel
55 21 2578 0947 Fax

EMC INTRODUCTION

Hypertherm's CE-marked equipment is built in compliance with standard EN50199. The equipment should be installed and used in accordance with the information below to achieve electromagnetic compatibility.

The limits required by EN50199 may not be adequate to completely eliminate interference when the affected equipment is in close proximity or has a high degree of sensitivity. In such cases it may be necessary to use other measures to further reduce interference.

This plasma equipment is designed for use only in an industrial environment.

INSTALLATION AND USE

The user is responsible for installing and using the plasma equipment according to the manufacturer's instructions. If electromagnetic disturbances are detected then it shall be the responsibility of the user to resolve the situation with the technical assistance of the manufacturer. In some cases this remedial action may be as simple as earthing the cutting circuit, see *Earthing of Workpiece*. In other cases it could involve constructing an electromagnetic screen enclosing the power source and the work complete with associated input filters. In all cases electromagnetic disturbances must be reduced to the point where they are no longer troublesome.

ASSESSMENT OF AREA

Before installing the equipment the user shall make an assessment of potential electromagnetic problems in the surrounding area. The following shall be taken into account:

- a. Other supply cables, control cables, signalling and telephone cables; above, below and adjacent to the cutting equipment.
- b. Radio and television transmitters and receivers.
- c. Computer and other control equipment.
- d. Safety critical equipment, for example guarding of industrial equipment.
- e. Health of the people around, for example the use of pacemakers and hearing aids.
- f. Equipment used for calibration or measurement.
- g. Immunity of other equipment in the environment. User shall ensure that other equipment being used in the environment is compatible. This may require additional protection measures.
- h. Time of day that cutting or other activities are to be carried out.

The size of the surrounding area to be considered will depend on the structure of the building and other activities that are taking place. The surrounding area may extend beyond the boundaries of the premises.

METHODS OF REDUCING EMISSIONS

Mains Supply

Cutting equipment must be connected to the mains supply according to the manufacturer's recommendations. If interference occurs, it may be necessary to take additional precautions such as filtering of the mains supply. Consideration should be given to shielding the supply cable of permanently installed cutting equipment, in metallic conduit or equivalent. Shielding should be electrically continuous throughout its length. The shielding should be connected to the cutting mains supply so that good electrical contact is maintained between the conduit and the cutting power source enclosure.

Maintenance of Cutting Equipment

The cutting equipment must be routinely maintained according to the manufacturer's recommendations. All access and service doors and covers should be closed and properly fastened when the cutting equipment is in operation. The cutting equipment should not be modified in any way except for those changes and adjustments covered in the manufacturer's instructions. In particular, the spark gaps of arc striking and stabilizing devices should be adjusted and maintained according to the manufacturer's recommendations.

Cutting Cables

The cutting cables should be kept as short as possible and should be positioned close together, running at or close to the floor level.

Equipotential Bonding

Bonding of all metallic components in the cutting installation and adjacent to it should be considered. However, metallic components bonded to the workpiece will increase the risk that the operator could receive a shock by touching these metallic components and the electrode at the same time. The operator should be insulated from all such bonded metallic components.

Earthing of Workpiece

Where the workpiece is not bonded to earth for electrical safety, nor connected to earth because of its size and position, for example, ship's hull or building steelwork, a connection bonding the workpiece to earth may reduce emissions in some, but not all instances. Care should be taken to prevent the earthing of the workpiece increasing the risk of injury to users, or damage to other electrical equipment. Where necessary, the connection of the workpiece to earth should be made by a direct connection to the workpiece, but in some countries where direct connection is not permitted, the bonding should be achieved by suitable capacitances selected according to national regulations.

Note. The cutting circuit may or may not be earthed for safety reasons. Changing the earthing arrangements should only be authorized by a person who is competent to assess whether the changes will increase the risk of injury, for example, by allowing parallel cutting current return paths which may damage the earth circuits of other equipment. Further guidance is given in IEC TC26 (sec)94 and IEC TC26/108A/CD Arc Welding Equipment Installation and Use.

Screening and Shielding

Selective screening and shielding of other cables and equipment in the surrounding area may alleviate problems of interference. Screening of the entire plasma cutting installation may be considered for special applications.

WARRANTY

WARNING

Genuine Hypertherm parts are the factory-recommended replacement parts for your Hypertherm system. Any damage caused by the use of other than genuine Hypertherm parts may not be covered by the Hypertherm warranty.

WARNING

You are responsible for the safe use of the Product. Hypertherm does not and cannot make any guarantee or warranty regarding the safe use of the Product in your environment.

GENERAL

Hypertherm, Inc. warrants that its Products shall be free from defects in materials and workmanship, if Hypertherm is notified of a defect (i) with respect to the power supply within a period of two (2) years from the date of its delivery to you, with the exception of G3 Series power supplies, which shall be within a period of three (3) years from the date of delivery to you, and (ii) with respect to the torch and leads within a period of one (1) year from its date of delivery to you. This warranty shall not apply to any Product which has been incorrectly installed, modified, or otherwise damaged. Hypertherm, at its sole option, shall repair, replace, or adjust, free of charge, any defective Products covered by this warranty which shall be returned with Hypertherm's prior authorization (which shall not be unreasonably withheld), properly packed, to Hypertherm's place of business in Hanover, New Hampshire, or to an authorized Hypertherm repair facility, all costs, insurance and freight prepaid. Hypertherm shall not be liable for any repairs, replacement, or adjustments of Products covered by this warranty, except those made pursuant to this paragraph or with Hypertherm's prior written consent. **The warranty above is exclusive and is in lieu of all other warranties, express, implied, statutory, or otherwise with respect to the Products or as to the results which may be obtained therefrom, and all implied warranties or conditions of quality or of merchantability or fitness for a particular purpose or against infringement. The foregoing shall constitute the sole and exclusive remedy for any breach by Hypertherm of its warranty.** Distributors/OEMs may offer different or additional warranties, but Distributors/OEMs are not authorized to give any additional warranty protection to you or make any representation to you purporting to be binding upon Hypertherm.

PATENT INDEMNITY

Except only in cases of products not manufactured by Hypertherm or manufactured by a person other than Hypertherm not in strict conformity with Hypertherm's specifications and in cases of designs, processes, formulae, or combinations not developed or purported to be developed by Hypertherm, Hypertherm will defend or settle, at its own expense, any suit or proceeding brought against you alleging that the use of the Hypertherm product, alone and not in combination with any other product not supplied by

Hypertherm, infringes any patent of any third party. You shall notify Hypertherm promptly upon learning of any action or threatened action in connection with any such alleged infringement, and Hypertherm's obligation to indemnify shall be conditioned upon Hypertherm's sole control of, and the indemnified party's cooperation and assistance in, the defense of the claim.

LIMITATION OF LIABILITY

In no event shall Hypertherm be liable to any person or entity for any incidental, consequential, indirect, or punitive damages (including but not limited to lost profits) regardless of whether such liability is based on breach of contract, tort, strict liability, breach of warranties, failure of essential purpose or otherwise and even if advised of the possibility of such damages.

LIABILITY CAP

In no event shall Hypertherm's liability, whether such liability is based on breach of contract, tort, strict liability, breach of warranties, failure of essential purpose or otherwise, for any claim action suit or proceeding arising out of or relating to the use of the Products exceed in the aggregate the amount paid for the Products that gave rise to such claim.

INSURANCE

At all times you will have and maintain insurance in such quantities and types, and with coverage sufficient and appropriate to defend and to hold Hypertherm harmless in the event of any cause of action arising from the use of the Products.

NATIONAL AND LOCAL CODES

National and Local codes governing plumbing and electrical installation shall take precedent over any instructions contained in this manual. **In no event** shall Hypertherm be liable for injury to persons or property damage by reason of any code violation or poor work practices.

TRANSFER OF RIGHTS

You may transfer any remaining rights you may have hereunder only in connection with the sale of all or substantially all of your assets or capital stock to a successor in interest who agrees to be bound by all of the terms and conditions of this Warranty.

Electromagnetic Compatibilityi
 Warrantyii

Section 1 Safety

Recognize Safety Information.....1-2
 Follow Safety Instructions.....1-2
 Cutting Can Cause Fire or Explosion1-2
 Electric Shock Can Kill.....1-3
 Cutting Can Produce Toxic Fumes1-3
 A Plasma Arc Can Cause Injury and Burns1-4
 Arc Rays Can Burn Eyes and Skin1-4
 Grounding Safety.....1-4
 Compressed Gas Equipment Safety1-5
 Gas Cylinders Can Explode If Damaged1-5
 Noise Can Damage Hearing.....1-5
 Pacemaker and Hearing Aid Operation1-5
 A Plasma Arc Can Damage Frozen Pipes1-5
 Additional Safety Information.....1-5

Section 1a Sécurité

Identifier les consignes de sécurité.....1a-2
 Suivre les instructions de sécurité1a-2
 Danger Avertissement Précaution1a-2
 Le coupage peut provoquer un incendie ou une explosion1a-2
 Prévention des incendies, Prévention des explosions1a-2
 Risque d'explosion argon-hydrogène et méthane.....1a-2
 Détonation de l'hydrogène lors du coupage de l'aluminium.....1a-2
 Les chocs électriques peuvent être fatals.....1a-3
 Prévention des chocs électriques1a-3
 Le coupage peut produire des vapeurs toxiques1a-3
 L'arc plasma peut provoquer des blessures ou des brûlures1a-4
 Torches à allumage instantané1a-4
 Les rayons de l'arc peuvent brûler les yeux et la peau.....1a-4
 Protection des yeux, Protection de la peau, Zone de coupage1a-4
 Mise à la masse et à la terre.....1a-4
 Câble de retour, Table de travail, Alimentation1a-4
 Sécurité des bouteilles de gaz comprimé1a-5
 Les bouteilles de gaz comprimé peuvent exploser en cas de dommages1a-5
 Le bruit peut provoquer des problèmes auditifs.....1a-5
 Pacemakers et prothèses auditives.....1a-5
 Un arc plasma peut endommager les tuyaux gelés.....1a-5

Section 2 Specifications

Specifications – RT80/RT80M2-2
 Torch Dimensions.....2-3

TABLE OF CONTENTS

Section 3 Setup

Upon Receipt	3-2
Claims	3-2
Contents of Box	3-2
Torch Installation	3-3

Section 4 Operation

Installing Torch Consumables	4-2
Torch Consumable Configurations	4-3
Adjust Gas Pressure and Current Setting	4-5
Hand Torch Operation	4-6
Safety Trigger Operation	4-6
Attach the Work Clamp	4-7
Starting a Cut from the Edge of the Workpiece	4-7
Hand Torch Cutting Technique	4-8
Piercing	4-9
Gouging	4-10
Cut Charts	4-11

Section 5 Maintenance and Parts

Routine Maintenance	5-2
Inspect Consumables	5-3
Parts	5-4
Torch Consumable Configurations	5-4
RT80 Hand Torch Assembly	5-6
RT80M Machine Torch Assembly	5-8
Accessories	5-10

Section 1

SAFETY

In this section:

Recognize Safety Information	1-2
Follow Safety Instructions	1-2
Cutting Can Cause Fire or Explosion	1-2
Electric Shock Can Kill	1-3
Cutting Can Produce Toxic Fumes	1-3
A Plasma Arc Can Cause Injury and Burns	1-4
Arc Rays Can Burn Eyes and Skin	1-4
Grounding Safety	1-4
Compressed Gas Equipment Safety	1-5
Gas Cylinders Can Explode If Damaged	1-5
Noise Can Damage Hearing	1-5
Pacemaker and Hearing Aid Operation	1-5
A Plasma Arc Can Damage Frozen Pipes	1-5
Additional Safety Information	1-5



RECOGNIZE SAFETY INFORMATION

The symbols shown in this section are used to identify potential hazards. When you see a safety symbol in this manual or on your machine, understand the potential for personal injury, and follow the related instructions to avoid the hazard.



FOLLOW SAFETY INSTRUCTIONS

Read carefully all safety messages in this manual and safety labels on your machine.

- Keep the safety labels on your machine in good condition. Replace missing or damaged labels immediately.
- Learn how to operate the machine and how to use the controls properly. Do not let anyone operate it without instruction.

- Keep your machine in proper working condition. Unauthorized modifications to the machine may affect safety and machine service life.

DANGER WARNING CAUTION

A signal word DANGER or WARNING is used with a safety symbol. DANGER identifies the most serious hazards.

- DANGER and WARNING safety labels are located on your machine near specific hazards.
- WARNING safety messages precede related instructions in this manual that may result in injury or death if not followed correctly.
- CAUTION safety messages precede related instructions in this manual that may result in damage to equipment if not followed correctly.



CUTTING CAN CAUSE FIRE OR EXPLOSION

Fire Prevention

- Be sure the area is safe before doing any cutting. Keep a fire extinguisher nearby.
- Remove all flammables within 35 feet (10 m) of the cutting area.
- Quench hot metal or allow it to cool before handling or before letting it touch combustible materials.
- Never cut containers with potentially flammable materials inside – they must be emptied and properly cleaned first.
- Ventilate potentially flammable atmospheres before cutting.
- When cutting with oxygen as the plasma gas, an exhaust ventilation system is required.

Explosion Prevention

- Do not use the plasma system if explosive dust or vapors may be present.
- Do not cut pressurized cylinders, pipes, or any closed container.
- Do not cut containers that have held combustible materials.



WARNING

Explosion Hazard
Argon-Hydrogen and Methane

Hydrogen and methane are flammable gases that present an explosion hazard. Keep flames away from cylinders and hoses that contain methane or hydrogen mixtures. Keep flames and sparks away from the torch when using methane or argon-hydrogen plasma.



WARNING

Hydrogen Detonation with
Aluminum Cutting

- When cutting aluminum underwater, or with the water touching the underside of the aluminum, free hydrogen gas may collect under the workpiece and detonate during plasma cutting operations.
- Install an aeration manifold on the floor of the water table to eliminate the possibility of hydrogen detonation. Refer to the Appendix section of this manual for aeration manifold details.



ELECTRIC SHOCK CAN KILL

Touching live electrical parts can cause a fatal shock or severe burn.

- Operating the plasma system completes an electrical circuit between the torch and the workpiece. The workpiece and anything touching the workpiece are part of the electrical circuit.
- Never touch the torch body, workpiece or the water in a water table when the plasma system is operating.

Electric Shock Prevention

All Hypertherm plasma systems use high voltage in the cutting process (200 to 400 VDC are common). Take the following precautions when operating this system:

- Wear insulated gloves and boots, and keep your body and clothing dry.
- Do not stand, sit or lie on – or touch – any wet surface when using the plasma system.
- Insulate yourself from work and ground using dry insulating mats or covers big enough to prevent any physical contact with the work or ground. If you must work in or near a damp area, use extreme caution.
- Provide a disconnect switch close to the power supply with properly sized fuses. This switch allows the operator to turn off the power supply quickly in an emergency situation.
- When using a water table, be sure that it is correctly connected to earth ground.

- Install and ground this equipment according to the instruction manual and in accordance with national and local codes.
- Inspect the input power cord frequently for damage or cracking of the cover. Replace a damaged power cord immediately. **Bare wiring can kill.**
- Inspect and replace any worn or damaged torch leads.
- Do not pick up the workpiece, including the waste cutoff, while you cut. Leave the workpiece in place or on the workbench with the work cable attached during the cutting process.
- Before checking, cleaning or changing torch parts, disconnect the main power or unplug the power supply.
- Never bypass or shortcut the safety interlocks.
- Before removing any power supply or system enclosure cover, disconnect electrical input power. Wait 5 minutes after disconnecting the main power to allow capacitors to discharge.
- Never operate the plasma system unless the power supply covers are in place. Exposed power supply connections present a severe electrical hazard.
- When making input connections, attach proper grounding conductor first.
- Each Hypertherm plasma system is designed to be used only with specific Hypertherm torches. Do not substitute other torches which could overheat and present a safety hazard.



CUTTING CAN PRODUCE TOXIC FUMES

Cutting can produce toxic fumes and gases that deplete oxygen and cause injury or death.

- Keep the cutting area well ventilated or use an approved air-supplied respirator.
- Do not cut in locations near degreasing, cleaning or spraying operations. The vapors from certain chlorinated solvents decompose to form phosgene gas when exposed to ultraviolet radiation.
- Do not cut metal coated or containing toxic materials, such as zinc (galvanized), lead, cadmium or beryllium, unless the area is well ventilated and the operator wears an air-supplied respirator. The coatings and any metals containing these elements can produce toxic fumes when cut.
- Never cut containers with potentially toxic materials inside – they must be emptied and properly cleaned first.
- This product, when used for welding or cutting, produces fumes or gases which contain chemicals known to the State of California to cause birth defects and, in some cases, cancer.



A PLASMA ARC CAN CAUSE INJURY AND BURNS

Instant-On Torches

Plasma arc comes on immediately when the torch switch is activated.

The plasma arc will cut quickly through gloves and skin.

- Keep away from the torch tip.
- Do not hold metal near the cutting path.
- Never point the torch toward yourself or others.



ARC RAYS CAN BURN EYES AND SKIN

Eye Protection Plasma arc rays produce intense visible and invisible (ultraviolet and infrared) rays that can burn eyes and skin.

- Use eye protection in accordance with applicable national or local codes.
- Wear eye protection (safety glasses or goggles with side shields, and a welding helmet) with appropriate lens shading to protect your eyes from the arc's ultraviolet and infrared rays.

Skin Protection Wear protective clothing to protect against burns caused by ultraviolet light, sparks and hot metal.

- Gauntlet gloves, safety shoes and hat.
- Flame-retardant clothing to cover all exposed areas.
- Cuffless trousers to prevent entry of sparks and slag.
- Remove any combustibles, such as a butane lighter or matches, from your pockets before cutting.

Arc Current
 Up to 100 A
 100-200 A
 200-400 A
 Over 400 A



Lens Shade	
AWS (USA)	ISO 4850
No. 8	No. 11
No. 10	No. 11-12
No. 12	No. 13
No. 14	No. 14

Cutting Area Prepare the cutting area to reduce reflection and transmission of ultraviolet light:

- Paint walls and other surfaces with dark colors to reduce reflection.
- Use protective screens or barriers to protect others from flash and glare.
- Warn others not to watch the arc. Use placards or signs.



GROUNDING SAFETY

Work Cable Attach the work cable securely to the workpiece or the work table with good metal-to-metal contact. Do not connect it to the piece that will fall away when the cut is complete.

Work Table Connect the work table to an earth ground, in accordance with appropriate national or local electrical codes.

Input Power

- Be sure to connect the power cord ground wire to the ground in the disconnect box.
- If installation of the plasma system involves connecting the power cord to the power supply, be sure to connect the power cord ground wire properly.
- Place the power cord's ground wire on the stud first, then place any other ground wires on top of the power cord ground. Fasten the retaining nut tightly.
- Tighten all electrical connections to avoid excessive heating.

COMPRESSED GAS EQUIPMENT SAFETY

- Never lubricate cylinder valves or regulators with oil or grease.
- Use only correct gas cylinders, regulators, hoses and fittings designed for the specific application.
- Maintain all compressed gas equipment and associated parts in good condition.
- Label and color-code all gas hoses to identify the type of gas in each hose. Consult applicable national or local codes.

**GAS CYLINDERS CAN EXPLODE IF DAMAGED**

Gas cylinders contain gas under high pressure. If damaged, a cylinder can explode.

- Handle and use compressed gas cylinders in accordance with applicable national or local codes.
- Never use a cylinder that is not upright and secured in place.
- Keep the protective cap in place over valve except when the cylinder is in use or connected for use.
- Never allow electrical contact between the plasma arc and a cylinder.
- Never expose cylinders to excessive heat, sparks, slag or open flame.
- Never use a hammer, wrench or other tool to open a stuck cylinder valve.

**NOISE CAN DAMAGE HEARING**

Prolonged exposure to noise from cutting or gouging can damage hearing.

- Use approved ear protection when using plasma system.
- Warn others nearby about the noise hazard.

**PACEMAKER AND HEARING AID OPERATION**

Pacemaker and hearing aid operation can be affected by magnetic fields from high currents. Pacemaker and hearing aid wearers should consult a doctor before going near any plasma arc cutting and gouging operations.

To reduce magnetic field hazards:

- Keep both the work cable and the torch lead to one side, away from your body.
- Route the torch leads as close as possible to the work cable.
- Do not wrap or drape the torch lead or work cable around your body.
- Keep as far away from the power supply as possible.

**A PLASMA ARC CAN DAMAGE FROZEN PIPES**

Frozen pipes may be damaged or can burst if you attempt to thaw them with a plasma torch.

ADDITIONAL SAFETY INFORMATION

1. ANSI Standard Z49.1, *Safety in Welding and Cutting*, American Welding Society, 550 LeJeune Road P.O. Box 351020, Miami, FL 33135
2. ANSI Standard Z49.2, *Fire Prevention in the Use of Cutting and Welding Processes*, American National Standards Institute 1430 Broadway, New York, NY 10018
3. ANSI Standard Z87.1, *Safe Practices for Occupation and Educational Eye and Face Protection*, American National Standards Institute, 1430 Broadway, New York, NY 10018
4. AWS F4.1, *Recommended Safe Practices for the Preparation for Welding and Cutting of Containers and Piping That Have Held Hazardous Substances*, American Welding Society 550 LeJeune Road, P.O. Box 351040, Miami, FL 33135
5. AWS F5.2, *Recommended Safe Practices for Plasma Arc Cutting*, American Welding Society 550 LeJeune Road, P.O. Box 351040, Miami, FL 33135
6. CGA Pamphlet P-1, *Safe Handling of Compressed Gases in Cylinders*, Compressed Gas Association 1235 Jefferson Davis Highway, Arlington, VA 22202
7. CSA Standard W117.2, *Code for Safety in Welding and Cutting*, Canadian Standards Association Standard Sales 178 Rexdale Boulevard, Rexdale, Ontario M9W 1R3, Canada
8. NFPA Standard 51B, *Cutting and Welding Processes*, National Fire Protection Association 470 Atlantic Avenue, Boston, MA 02210
9. NFPA Standard 70-1978, *National Electrical Code*, National Fire Protection Association, 470 Atlantic Avenue, Boston, MA 02210
10. OSHA, *Safety and Health Standards*, 29FR 1910 U.S. Government Printing Office, Washington, D.C. 20402

Dans cette section :

Identifier les consignes de sécurité	1a-2
Suivre les instructions de sécurité.....	1a-2
Danger Avertissement Précaution.....	1a-2
Le coupage peut provoquer un incendie ou une explosion.....	1a-2
Prévention des incendies, Prévention des explosions	1a-2
Risque d'explosion argon-hydrogène et méthane	1a-2
Détonation de l'hydrogène lors du coupage de l'aluminium	1a-2
Les chocs électriques peuvent être fatals	1a-3
Prévention des chocs électriques	1a-3
Le coupage peut produire des vapeurs toxiques	1a-3
L'arc plasma peut provoquer des blessures ou des brûlures	1a-4
Torches à allumage instantané.....	1a-4
Les rayons de l'arc peuvent brûler les yeux et la peau	1a-4
Protection des yeux, Protection de la peau, Zone de coupage	1a-4
Mise à la masse et à la terre	1a-4
Câble de retour, Table de travail, Alimentation	1a-4
Sécurité des bouteilles de gaz comprimé	1a-5
Les bouteilles de gaz comprimé peuvent exploser en cas de dommages.....	1a-5
Le bruit peut provoquer des problèmes auditifs	1a-5
Pacemakers et prothèses auditives	1a-5
Un arc plasma peut endommager les tuyaux gelés	1a-5



IDENTIFIER LES CONSIGNES DE SÉCURITÉ

Les symboles indiqués dans cette section sont utilisés pour identifier les risques éventuels. Si vous trouvez un symbole de sécurité, que ce soit dans ce manuel ou sur l'équipement, soyez conscient des risques de blessures et suivez les instructions correspondantes afin d'éviter ces risques.



SUIVRE LES INSTRUCTIONS DE SÉCURITÉ

Lire attentivement toutes les consignes de sécurité dans le présent manuel et sur les étiquettes de sécurité se trouvant sur la machine.

- Les étiquettes de sécurité doivent rester lisibles. Remplacer immédiatement les étiquettes manquantes ou abîmées.
- Apprendre à faire fonctionner la machine et à utiliser correctement les commandes. Ne laisser personne utiliser la machine sans connaître son fonctionnement.

- Garder la machine en bon état. Des modifications non autorisées sur la machine peuvent engendrer des problèmes de sécurité et raccourcir la durée d'utilisation de l'équipement.

DANGER AVERTISSEMENT PRÉCAUTION

Les signaux DANGER ou AVERTISSEMENT sont utilisés avec un symbole de sécurité, DANGER correspondant aux risques les plus sérieux.

- Les étiquettes de sécurité DANGER et AVERTISSEMENT sont situées sur la machine pour signaler certains dangers spécifiques.
- Les messages d'AVERTISSEMENT précèdent les instructions d'utilisation expliquées dans ce manuel et signalent les risques de blessures ou de mort au cas où ces instructions ne seraient pas suivies correctement.
- Les messages de PRÉCAUTION précèdent les instructions d'utilisation contenues dans ce manuel et signalent que le matériel risque d'être endommagé si les instructions ne sont pas suivies correctement.



LE COUPAGE PEUT PROVOQUER UN INCENDIE OU UNE EXPLOSION

Prévention des incendies

- Avant de commencer, s'assurer que la zone de coupage ne présente aucun danger. Conserver un extincteur à proximité.
- Éloigner toute matière inflammable à une distance d'au moins 10 m du poste de coupage.
- Tremper le métal chaud ou le laisser refroidir avant de le manipuler ou avant de le mettre en contact avec des matériaux combustibles.
- Ne jamais couper des récipients pouvant contenir des matières inflammables avant de les avoir vidés et nettoyés correctement.
- Aérer toute atmosphère potentiellement inflammable avant d'utiliser un système plasma.
- Lors de l'utilisation d'oxygène comme gaz plasma, un système de ventilation par aspiration est nécessaire.

Prévention des explosions

- Ne pas couper en présence de poussière ou de vapeurs.
- Ne pas couper de bouteilles, de tuyaux ou autres récipients fermés et pressurisés.
- Ne pas couper de récipients contenant des matières combustibles.



AVERTISSEMENT

Risque d'explosion argon-hydrogène et méthane

L'hydrogène et le méthane sont des gaz inflammables et potentiellement explosifs. Conserver à l'écart de toute flamme les bouteilles et tuyaux contenant des mélanges à base d'hydrogène ou de méthane. Maintenir toute flamme et étincelle à l'écart de la torche lors de l'utilisation d'un plasma d'argon-hydrogène ou de méthane.



AVERTISSEMENT

Détonation de l'hydrogène lors du coupage de l'aluminium

- Lors du coupage de l'aluminium sous l'eau, ou si l'eau touche la partie inférieure de la pièce d'aluminium, de l'hydrogène libre peut s'accumuler sous la pièce à couper et détonner lors du coupage plasma.
- Installer un collecteur d'aération au fond de la table à eau afin d'éliminer les risques de détonation de l'hydrogène. Se référer à l'annexe du manuel pour plus de renseignements sur les collecteurs d'aération.



LES CHOCS ÉLECTRIQUES PEUVENT ÊTRE FATALS

Toucher une pièce électrique sous tension peut provoquer un choc électrique fatal ou des brûlures graves.

- La mise en fonctionnement du système plasma ferme un circuit électrique entre la torche et la pièce à couper. La pièce à couper et tout autre élément en contact avec cette pièce font partie du circuit électrique.
- Ne jamais toucher le corps de la torche, la pièce à couper ou l'eau de la table à eau pendant le fonctionnement du système plasma.

Prévention des chocs électriques

Tous les systèmes plasma Hypertherm utilisent des hautes tensions pour le coupage (souvent de 200 à 400 V). On doit prendre les précautions suivantes quand on utilise le système plasma :

- Porter des bottes et des gants isolants et garder le corps et les vêtements au sec.
- Ne pas se tenir, s'asseoir ou se coucher sur une surface mouillée, ni la toucher quand on utilise le système plasma.
- S'isoler de la surface de travail et du sol en utilisant des tapis isolants secs ou des couvertures assez grandes pour éviter tout contact physique avec le travail ou le sol. S'il s'avère nécessaire de travailler dans ou près d'un endroit humide, procéder avec une extrême prudence.
- Installer un sectionneur avec fusibles appropriés, à proximité de la source de courant. Ce dispositif permet à l'opérateur d'arrêter rapidement la source de courant en cas d'urgence.
- En cas d'utilisation d'une table à eau, s'assurer que cette dernière est correctement mise à la terre.

- Installer et mettre à la terre l'équipement selon les instructions du présent manuel et conformément aux codes électriques locaux et nationaux.
- Inspecter fréquemment le cordon d'alimentation primaire pour s'assurer qu'il n'est ni endommagé, ni fendu. Remplacer immédiatement un cordon endommagé.

Un câble dénudé peut tuer.

- Inspecter et remplacer les câbles de la torche qui sont usés ou endommagés.
- Ne pas saisir la pièce à couper ni les chutes lors du coupage. Laisser la pièce à couper en place ou sur la table de travail, le câble de retour connecté lors du coupage.
- Avant de vérifier, de nettoyer ou de remplacer les pièces de la torche, couper l'alimentation ou débrancher la prise de courant.
- Ne jamais contourner ou court-circuiter les verrouillages de sécurité.
- Avant d'enlever le capot du système ou de la source de courant, couper l'alimentation électrique. Attendre ensuite 5 minutes pour que les condensateurs se déchargent.
- Ne jamais faire fonctionner le système plasma sans que les capots de la source de courant ne soient en place. Les raccords exposés de la source de courant sont extrêmement dangereux.
- Lors de l'installation des connexions, attacher tout d'abord la prise de terre appropriée.
- Chaque système plasma Hypertherm est conçu pour être utilisé uniquement avec des torches Hypertherm spécifiques. Ne pas utiliser des torches inappropriées qui pourraient surchauffer et présenter des risques pour la sécurité.



LE COUPAGE PEUT PRODUIRE DES VAPEURS TOXIQUES

Le coupage peut produire des vapeurs et des gaz toxiques qui réduisent le niveau d'oxygène dans l'air et peuvent provoquer des blessures, voire la mort.

- Conserver le poste de coupage bien aéré ou utiliser un masque respiratoire homologué.
- Ne pas procéder au coupage près d'endroits où s'effectuent le dégraissage, le nettoyage ou la vaporisation. Certains solvants chlorés se décomposent sous l'effet des rayons ultraviolets et forment du phosgène.
- Ne pas couper des métaux peints ou contenant des matières toxiques comme le zinc (galvanisé), le plomb, le cadmium ou le béryllium, à moins que la zone de travail

soit très bien ventilée et que l'opérateur porte un masque respiratoire. Les revêtements et métaux contenant ces matières peuvent produire des vapeurs toxiques lors du coupage.

- Ne jamais couper de récipients pouvant contenir des matières inflammables avant de les avoir vidés et nettoyés correctement.
- Quand on utilise ce produit pour le soudage ou le coupage, il dégage des fumées et des gaz qui contiennent des produits chimiques qui, selon l'État de Californie, provoquent des anomalies congénitales et, dans certains cas, le cancer.



L'ARC PLASMA PEUT PROVOQUER DES BLESSURES OU DES BRÛLURES

Torches à allumage instantané

L'arc plasma s'allume immédiatement après que la torche soit mise en marche.

L'arc plasma coupe facilement les gants et la peau.

- Rester éloigné de l'extrémité de la torche.
- Ne pas tenir de métal près de la trajectoire de coupe.
- Ne jamais pointer la torche vers soi ou d'autres personnes.



LES RAYONS DE L'ARC PEUVENT BRÛLER LES YEUX ET LA PEAU

Protection des yeux Les rayons de l'arc plasma produisent de puissants rayons visibles ou invisibles (ultraviolets et infrarouges) qui peuvent brûler les yeux et la peau.

- Utiliser des lunettes de sécurité conformément aux codes locaux ou nationaux en vigueur.
- Porter des lunettes de protection (lunettes ou masque muni d'écrans latéraux et encore masque de soudure) avec des verres teintés appropriés pour protéger les yeux des rayons ultraviolets et infrarouges de l'arc.

Protection de la peau Porter des vêtements de sécurité pour se protéger contre les brûlures que peuvent causer les rayons ultraviolets, les étincelles et le métal brûlant :

- Gants à crispin, chaussures et casque de sécurité.
- Vêtements ignifuges couvrant toutes les parties exposées du corps.
- Pantalon sans revers pour éviter que des étincelles ou des scories puissent s'y loger.
- Avant le coupage, retirer de ses poches tout objet combustible comme les briquets au butane ou les allumettes.

Courant de l'arc

Jusqu'à 100 A
100-200 A
200-400 A
Plus de 400 A



Puissance des verres teintés

AWS (É.-U.)

N° 8

N° 10

N° 12

N° 14

ISO 4850

N° 11

N° 11-12

N° 13

N° 14



Zone de coupage Préparer la zone de coupage afin de réduire la réverbération et la transmission de la lumière ultraviolette :

- Peindre les murs et autres surfaces de couleur sombre pour réduire la réflexion de la lumière.
- Utiliser des écrans et autres dispositifs de protection afin de protéger les autres personnes de la lumière et de la réverbération.
- Prévenir les autres personnes de ne pas regarder l'arc. Utiliser des affiches ou des panneaux.



MISE À LA MASSE ET À LA TERRE

Câble de retour Bien fixer le câble de retour (ou de masse) à la pièce à couper ou à la table de travail de façon à assurer un bon contact métal-métal. Ne pas fixer le câble de retour à la partie de la pièce qui doit se détacher.

Table de travail Raccorder la table de travail à la terre, conformément aux codes de sécurité locaux ou nationaux appropriés.

Alimentation

- S'assurer que le fil de terre du cordon d'alimentation est connecté à la terre dans le coffret du sectionneur.
- S'il est nécessaire de brancher le cordon d'alimentation à la source de courant lors de l'installation du système, s'assurer que le fil de terre est correctement branché.
- Placer tout d'abord le fil de terre du cordon d'alimentation sur le plot de mise à la terre puis placer les autres fils de terre par-dessus. Bien serrer l'écrou de retenue.
- S'assurer que toutes les connexions sont bien serrées pour éviter la surchauffe.

SÉCURITÉ DES BOUTEILLES DE GAZ COMPRIMÉ

- Ne jamais lubrifier les robinets des bouteilles ou les régulateurs avec de l'huile ou de la graisse.
- Utiliser uniquement les bouteilles, régulateurs, tuyaux et accessoires appropriés et conçus pour chaque application spécifique.
- Entretenir l'équipement et les pièces d'équipement à gaz comprimé afin de les garder en bon état.
- Étiqueter et coder avec des couleurs tous les tuyaux de gaz afin d'identifier le type de gaz contenu dans chaque tuyau. Se référer aux codes locaux ou nationaux en vigueur.



LES BOUTEILLES DE GAZ COMPRIMÉ PEUVENT EXPLOSER EN CAS DE DOMMAGES

Les bouteilles de gaz contiennent du gaz à haute pression. Si une bouteille est endommagée, elle peut exploser.

- Manipuler et utiliser les bouteilles de gaz comprimé conformément aux codes locaux ou nationaux.
- Ne jamais utiliser une bouteille qui n'est pas placée à la verticale et bien assujettie.
- Le capuchon de protection doit être placé sur le robinet sauf si la bouteille est en cours d'utilisation ou connectée pour utilisation.
- Éviter à tout prix le contact électrique entre l'arc plasma et une bouteille.
- Ne jamais exposer des bouteilles à une chaleur excessive, aux étincelles, aux scories ou aux flammes nues.
- Ne jamais utiliser des marteaux, des clés ou d'autres outils pour débloquer le robinet des bouteilles.



LE BRUIT PEUT PROVOQUER DES PROBLÈMES AUDITIFS

Une exposition prolongée au bruit du coupage ou du gougeage peut provoquer des problèmes auditifs.

- Utiliser un casque de protection homologué lors de l'utilisation du système plasma.
- Prévenir les personnes aux alentours des risques encourus en cas d'exposition au bruit.



PACEMAKERS ET PROTHÈSES AUDITIVES

Les champs magnétiques produits par les courants à haute tension peuvent affecter le fonctionnement des prothèses auditives et des pacemakers. Les personnes portant ce type d'appareil doivent consulter un médecin avant de s'approcher d'un lieu où s'effectue le coupage ou le gougeage plasma.

Pour réduire les risques associés aux champs magnétiques :

- Garder loin de soi et du même côté du corps le câble de retour et le faisceau de la torche.
- Faire passer le faisceau de la torche le plus près possible du câble de retour.
- Ne pas s'enrouler le faisceau de la torche ou le câble de retour autour du corps.
- Se tenir le plus loin possible de la source de courant.



UN ARC PLASMA PEUT ENDOMMAGER LES TUYAUX GELÉS

Les tuyaux gelés peuvent être endommagés ou éclater si l'on essaie de les dégeler avec une torche plasma.

In this section:

Specifications – RT80/RT80M	2-2
Torch Dimensions.....	2-3

SPECIFICATIONS

Specifications – RT80/RT80M Air Cooled Torch

Cutting Capacity At 80 Amps	
Recommended capacity	7/8 inch (22 mm)
Maximum capacity	1-1/8 inch (29 mm)
Severance capacity	1-1/2 inch (38 mm)
Gouging Capability (metal removal rate on mild steel)	12.2 pounds (5.5 kg) /hour
Gas Supply	
Gas Type	Air or Nitrogen
Gas Quality, Air	Clean, dry, oil-free
Gas Quality, Nitrogen	99.995% pure
Gas Inlet Pressure	90 psig (6.1 bar)
Gas Flow	400 scfh/6.7 scfm (189 l/min)
Duty Cycle (X) at 104°F (40°C)	
PMX1100	50% ($I_2 = 80$ A, $U_2 = 140$ V) 100% ($I_2 = 57$ A, $U_2 = 140$ V) See data tag on power supply for more information on duty cycle.
RT80/RT80M	100% ($I_2 = 80$ A, $U_2 = 140$ V)
Weight	
RT80	7.4 pounds (3.4 kg) with 25 ft (7.5 m) lead 14.1 pounds (6.4 kg) with 50 ft (15 m) lead
RT80M	8.5 pounds (3.9 kg) with 25 ft (7.5 m) lead 15.2 pounds (6.9 kg) with 50 ft (15 m) lead

Torch Dimensions

RT80 Hand Torch Dimensions

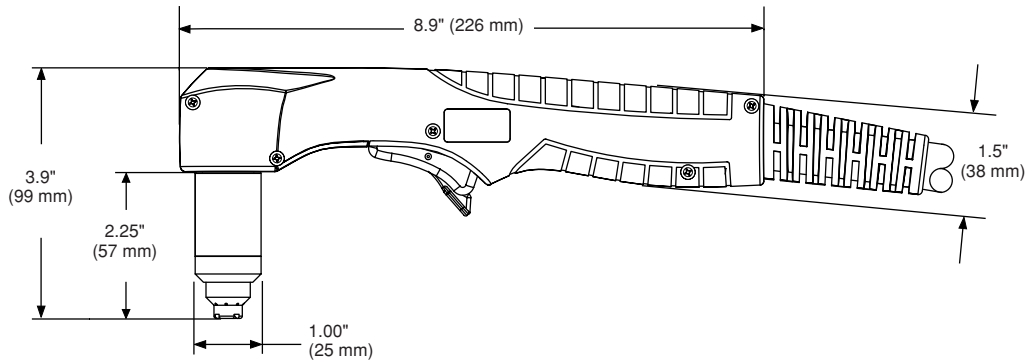

RT80M Machine Torch Dimensions

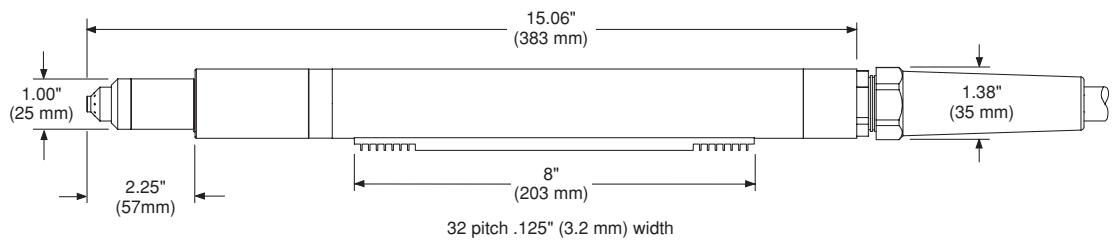

Section 3

SETUP

In this section:

Upon Receipt	3-2
Claims	3-2
Contents of Box	3-2
Torch Installation	3-3

Upon Receipt

1. Check that all items on your order have been received. Contact your distributor if any items are missing or damaged.
2. If there is evidence of damage, refer to *Claims*, below. All communications regarding this equipment must include the model number and serial number located on the back of the power supply.
3. Read the *Safety* section of this manual before setting up and operating this Hypertherm system.

Claims

Claims for damage during shipment: If your unit was damaged during shipment, you must file a claim with the carrier. Hypertherm will furnish you with a copy of the bill of lading upon request. If you need additional assistance, call the nearest Hypertherm office listed in the front of this manual.

Claims for defective or missing merchandise: If any component is missing or defective, contact your Hypertherm distributor. If you need additional assistance, call the nearest Hypertherm office listed in the front of this manual.

Contents of Box

Kit 087033

Part Number	Description	Qty
087033	RT80 25' hand torch assembly	1
110439	RT80 / PMX1100 operation label	1

Kit 087034

Part Number	Description	Qty
087034	RT80 50' hand torch assembly	1
110439	RT80 / PMX1100 operation label	1

Kit 087035

Part Number	Description	Qty
087035	RT80M 25' machine torch assembly	1
110439	RT80 / PMX1100 operation label	1

Kit 087036

Part Number	Description	Qty
087036	RT80M 50' machine torch assembly	1
110439	RT80 / PMX1100 operation label	1

Torch Installation

- ① Turn OFF power.

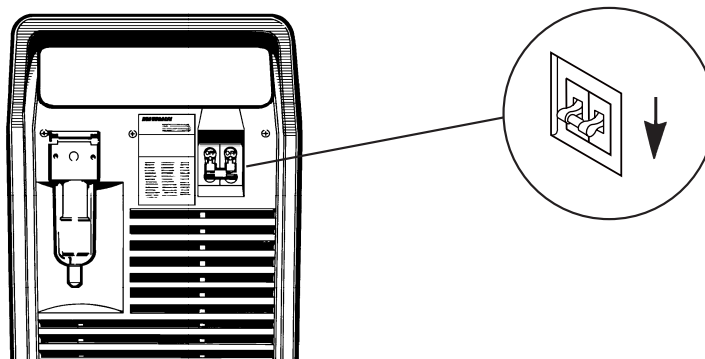

- ② Remove power cord from power receptacle.

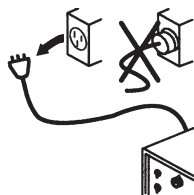

- ③
1. Align the connector key plug on the torch lead with the connector receptacle key slot on the power supply and push in until the pins seat. The top of the torch connector is marked "TOP".
 2. Before tightening, turn the connector securing ring 1/4 turn to the left to ensure that the securing ring threads and the connector receptacle threads are aligned.
 3. Turn the securing ring to the right to tighten.
 4. Clean the top of the power supply and apply the new operation label over the existing label.

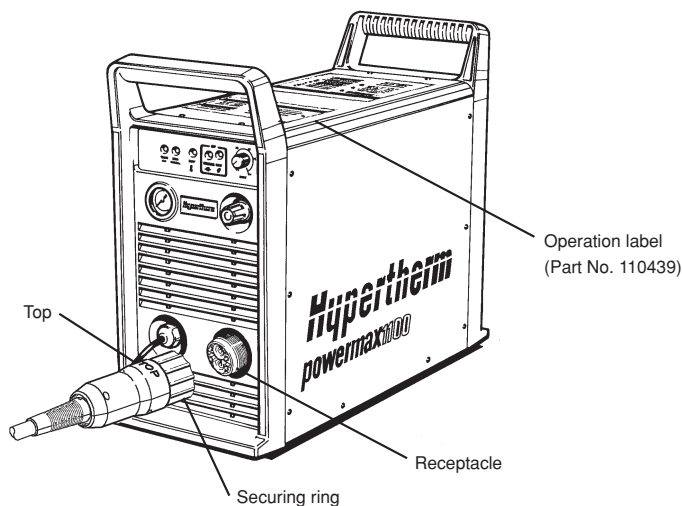

Section 4

OPERATION

In this section:

Installing Torch Consumables	4-2
Torch Consumable Configurations	4-3
Adjust Gas Pressure and Current Setting	4-5
Hand Torch Operation	4-6
Safety Trigger Operation	4-6
Attach the Work Clamp	4-7
Starting a Cut from the Edge of the Workpiece	4-7
Hand Torch Cutting Technique	4-8
Piercing	4-9
Gouging	4-10
Cut Charts	4-11

Installing Torch Consumables

		WARNING INSTANT-ON TORCHES PLASMA ARC CAN CAUSE INJURY AND BURNS
	↓	<p>Plasma arc comes on immediately when the torch switch is activated. The plasma arc will quickly burn through gloves and skin. Make sure power is OFF before changing consumables.</p>

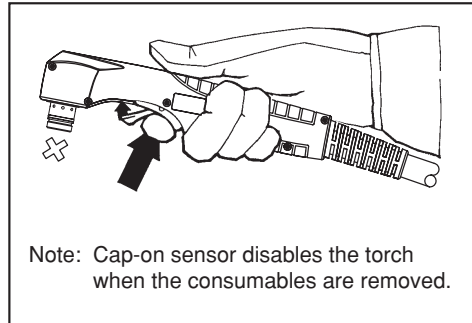
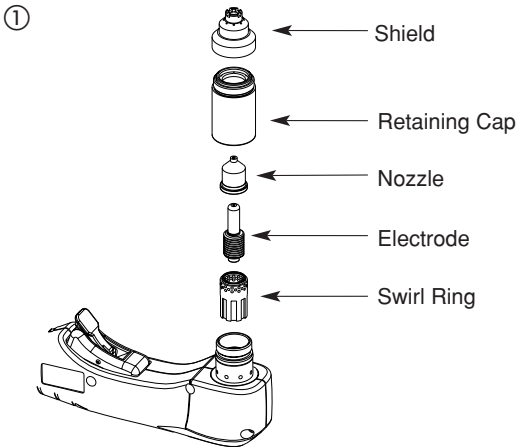

② Hand tighten only.

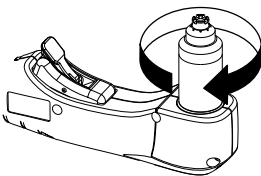

Torch Consumable Configurations

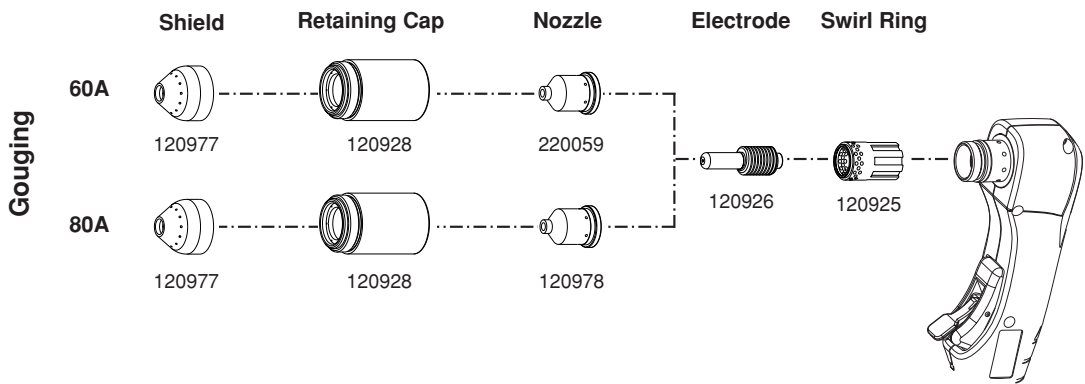
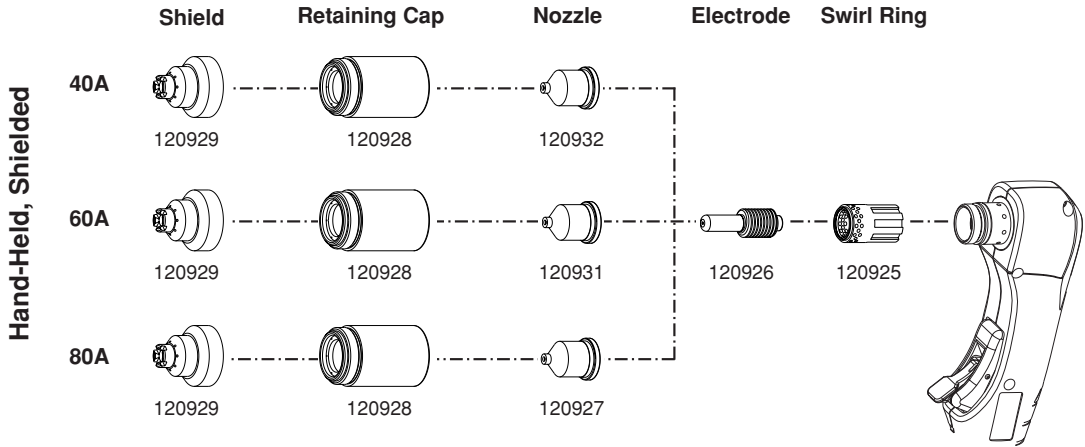

Torch Consumable Configurations

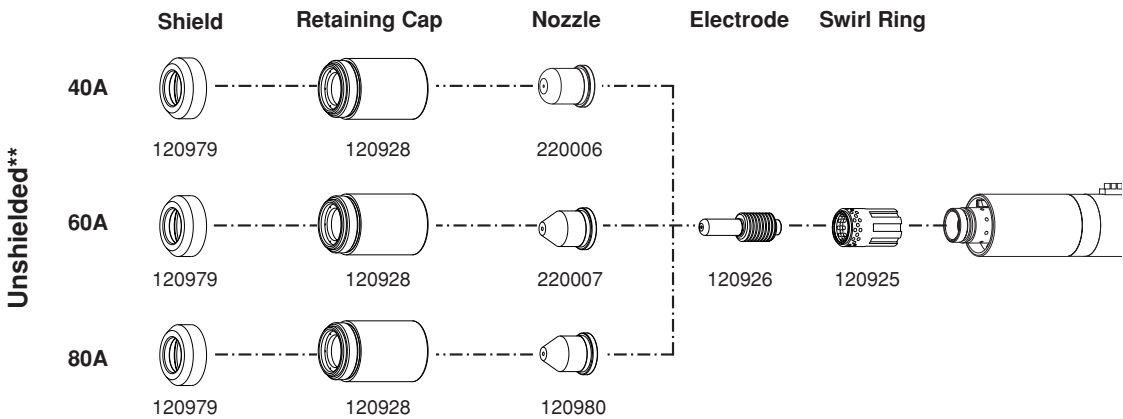
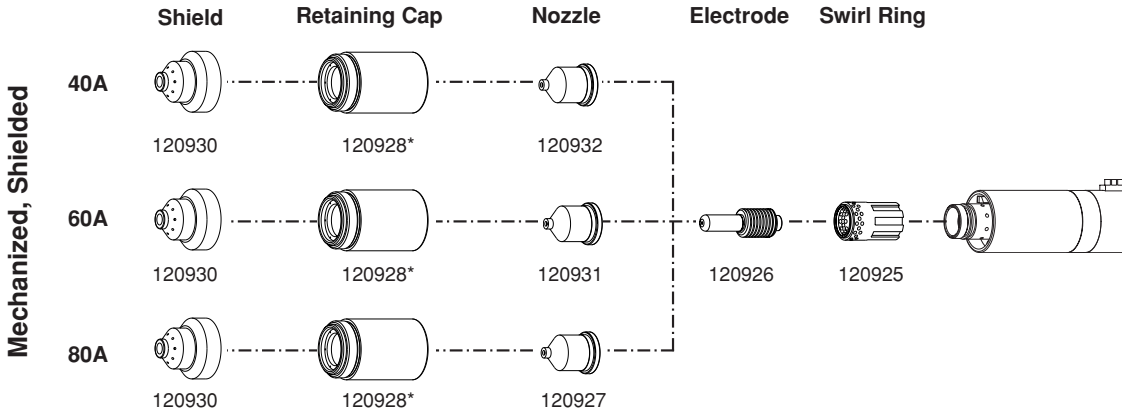

Ohmic Sensing Retaining Cap

40A-80A



* Use an ohmic sensing cap when a compatible torch height controller is installed.

** In CE countries, unshielded consumables may only be used in mechanized torch applications.

Maintain torch-to-work distance of approximately 1/8 inch (3mm).

Adjust Gas Pressure and Current Setting

①

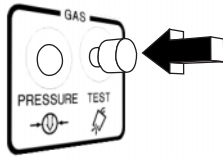

Press and hold gas test button while adjusting gas pressure.



Pull regulator knob to unlock.

③



Push regulator knob to lock.

④

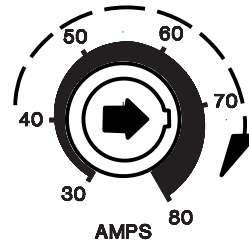

Set to desired current.

<p>②</p>	<p>25' 50'</p> <p>7.5 m 15 m</p>	
<p>Cutting</p>	<p>70 psi 4.8 BAR</p>	<p>75 psi 5.2 BAR</p>
<p>Gouging</p>	<p>50 psi 3.4 BAR</p>	<p>60 psi 4.1 BAR</p>

Set pressure according to process and lead length.

Hand Torch Operation





WARNING
INSTANT-ON TORCHES
PLASMA ARC CAN CAUSE INJURY AND BURNS

Plasma arc comes on immediately when the torch switch is activated.
The plasma arc will quickly burn through gloves and skin.

- Keep away from the torch tip.
- Do not hold the workpiece, and keep your hands clear of the cutting path.
- Never point the torch toward yourself or others.
- Never use with Pendant Switch.

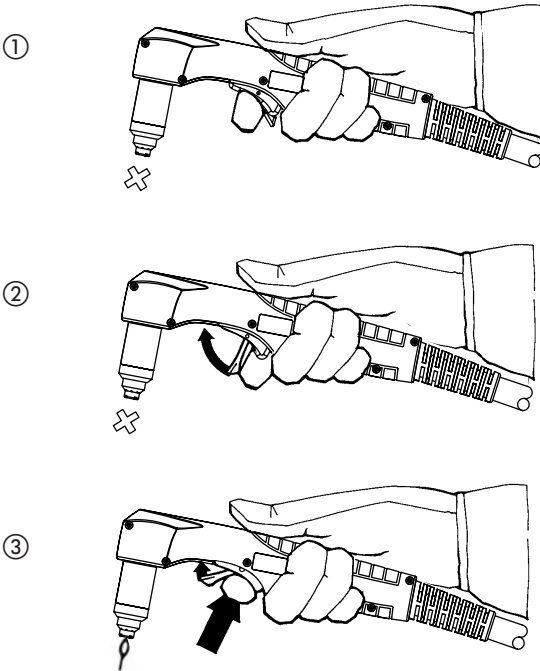
Safety Trigger Operation



		<p>WARNING SPARKS AND HOT METAL CAN INJURE EYES AND BURN SKIN</p>
<p>When firing the torch at an angle, sparks and hot metal will spray out from the nozzle. Point the torch away from yourself and others.</p>		

Attach the Work Clamp

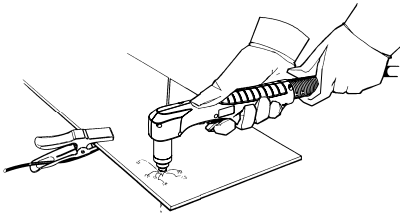

Attach the work clamp securely to the workpiece. Remove rust, paint or other coatings to ensure good electrical contact.

Attach the work clamp as close as possible to the area being cut, to reduce exposure to electromagnetic fields (EMF).

Do not attach the work clamp to the portion that will fall away.

Starting a Cut from the Edge of the Workpiece

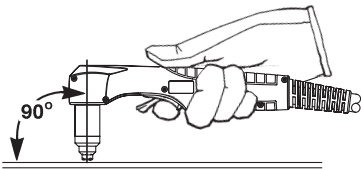

Hold the torch nozzle vertical at the edge of the workpiece.

Start cutting from the edge of the workpiece.

Pause at the edge until the arc has completely cut through the workpiece.

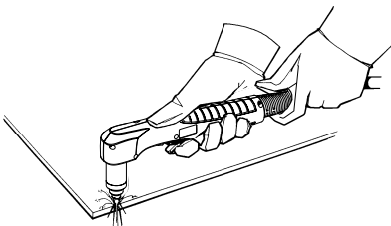

Then, proceed with the cut.

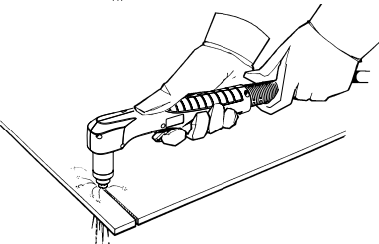

OPERATION

Hand Torch Cutting Technique

Firing the torch unnecessarily reduces nozzle and electrode life.



When cutting, make sure that sparks are exiting from the bottom of the workpiece.

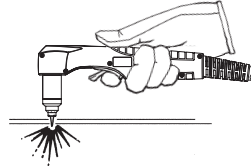

If sparks are spraying up from the workpiece, you are moving the torch too fast, or without sufficient power.

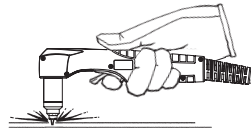

Position the torch nozzle at a vertical position and watch the arc as it cuts along the line.

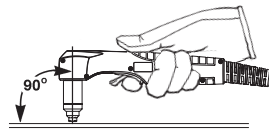

Unshielded Consumables. Maintain an approximate 1/8 inch (3 mm) torch-to-work distance.

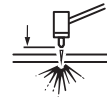

Shielded Consumables. Do not push down on the torch when cutting. Lightly drag the torch across the workpiece to maintain a steady cut.

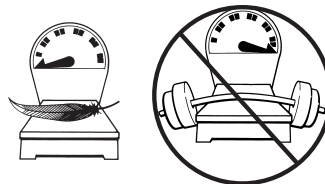

-
- Pulling the torch through the cut is easier than pushing it.
 - To cut thin material, reduce the amps until you get the best quality cut.
 - For straight-line cuts, use a straight edge as a guide. To cut circles, use a template or a Hypertherm circle cut guide, Part No. 027668.

Piercing

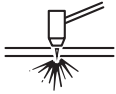

		<p>WARNING SPARKS AND HOT METAL CAN INJURE EYES AND BURN SKIN</p>
<p>When firing the torch at an angle, sparks and hot metal will spray out from the nozzle. Point the torch away from yourself and others.</p>		

Hold the torch so that the nozzle is within 1/8 inch (3 mm) from the workpiece before firing the torch.

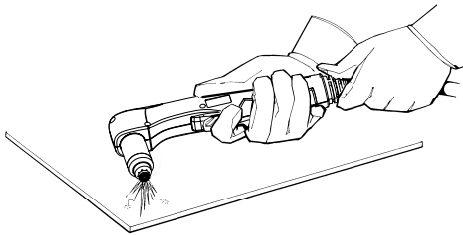

Fire the torch at an angle to the workpiece, then slowly rotate it to an upright position.

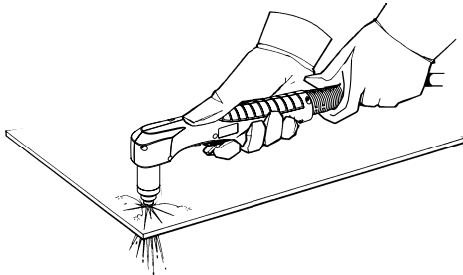

When sparks are exiting from the bottom of the workpiece, the arc has pierced through the material.

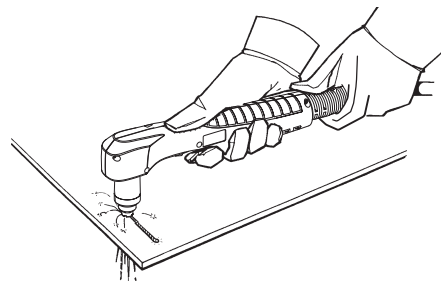

When the pierce is complete, proceed with the cut.

OPERATION

Gouging



		<p>WARNING SPARKS AND HOT METAL CAN INJURE EYES AND BURN SKIN</p>
<p>When firing the torch at an angle, sparks and hot metal will spray out from the nozzle. Point the torch away from yourself and others.</p>		

Hold the torch so that the nozzle is within 1/16 inch (1.5 mm) from the workpiece before firing the torch.

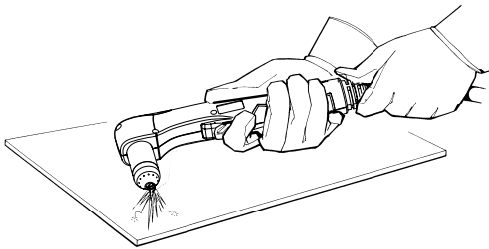

Hold the torch at a 45 degree angle to the work piece. Pull the trigger to obtain a pilot arc. Transfer the arc to the work piece.

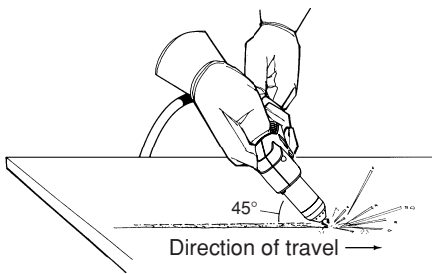

Maintain a 45° angle, approximately, from the workpiece.

Feed into the gouge.

Note: A heat shield is available for added hand and torch protection, Part No. 220049.

Cut Charts

80 Amp Mechanized Shielded Consumables

- Torch-to-work distance for the following cut chart is 1/16 inch (1.5 mm) for all cuts.

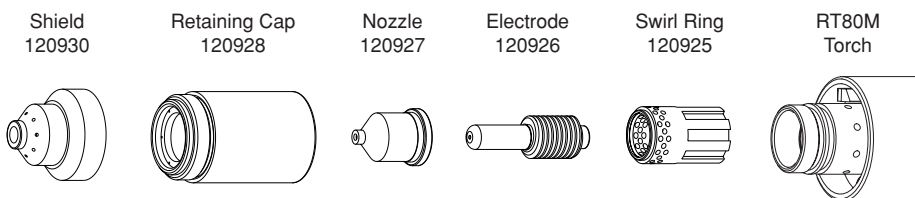

Mild Steel

Arc Current	Arc Voltage	Motion Delay	Material Thickness		Maximum Travel Speeds		Optimum Travel Speeds	
			Inches	mm	IPM	mm/min	IPM	mm/min
80	132	0.25	3/16"	4.8	216	5486	140	3556
	134	0.50	1/4"	6.4	161	4089	105	2667
	137		3/8"	9.5	94	2388	61	1549
	140		1/2"	12.7	60	1524	39	991
	145	1.00	5/8"	15.9	40	1016	26	660
	148	*	3/4"	19.0	31	787	20	508
	150		7/8"	22.2	23	584	15	381
	156		1"	25.4	16	406	10	254

Stainless

Arc Current	Arc Voltage	Motion Delay	Material Thickness		Maximum Travel Speeds		Optimum Travel Speeds	
			Inches	mm	IPM	mm/min	IPM	mm/min
80	134	0.25	3/16"	4.8	216	5486	140	3556
	136	0.50	1/4"	6.4	158	4013	103	2616
	139	0.75	3/8"	9.5	83	2108	54	1372
	142		1/2"	12.7	50	1270	33	838
	145	*	5/8"	15.9	34	864	22	559
	150		3/4"	19.0	24	610	16	406
	153		1"	25.4	14	356	9	229

Aluminum

Arc Current	Arc Voltage	Motion Delay	Material Thickness		Maximum Travel Speeds		Optimum Travel Speeds	
			Inches	mm	IPM	mm/min	IPM	mm/min
80	134	0.25	1/8"	3.2	454	11532	295	7493
	139		1/4"	6.4	176	4470	114	2896
	143	0.75	3/8"	9.5	121	3073	60	1524
	146		1/2"	12.7	75	1905	37	940
	154	*	3/4"	19.0	37	940	19	483

* Piercing material in this range is not recommended, it will shorten consumable life. Starting cuts at the edge of the metal is recommended.

Maximum travel speeds are the fastest travel speeds possible to cut the material without regard to cut quality. Optimum travel speeds provide the best cut angle, least dross and best cut surface finish. **Remember that cut charts are intended to provide a good starting point for each different cut assignment.** Every cutting system requires "fine tuning" for each cutting application in order to obtain the desired cut quality.

OPERATION

60 Amp Mechanized Shielded Consumables

- Torch-to-work distance for the following cut chart is 1/16 inch (1.5 mm) for all cuts.

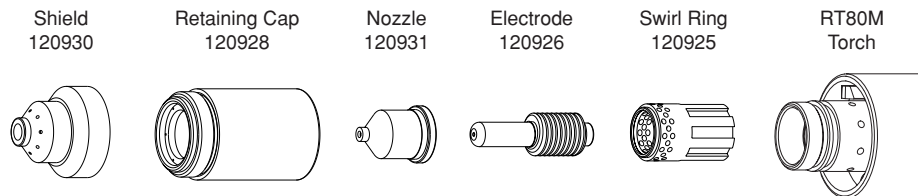

Mild Steel

Arc Current	Arc Voltage	Motion Delay	Material Thickness		Maximum Travel Speeds		Optimum Travel Speeds	
			Inches	mm	IPM	mm/min	IPM	mm/min
60	134	0	16 Ga	1.5	627	15926	502	12751
	134		10 Ga	3.4	264	6706	211	5359
	138	0.25	1/4"	6.4	132	3353	86	2184
	141	0.75	3/8"	9.5	63	1600	41	1041
	141	*	1/2"	12.7	42	1067	27	686
	147		5/8"	15.9	31	787	20	512
	153		3/4"	19.0	22	559	14	363

Stainless

Arc Current	Arc Voltage	Motion Delay	Material Thickness		Maximum Travel Speeds		Optimum Travel Speeds	
			Inches	mm	IPM	mm/min	IPM	mm/min
60	134	0	16 Ga	1.5	625	15875	406	10312
	136	0.25	10 Ga	3.4	244	6198	159	4039
	139	0.50	1/4"	6.4	110	2794	72	1829
	145	0.75	3/8"	9.5	53	1346	34	864
	146	*	1/2"	12.7	35	889	23	584
	149		5/8"	15.9	26	660	17	429
	154		3/4"	19.0	18	457	12	297

Aluminum

Arc Current	Arc Voltage	Motion Delay	Material Thickness		Maximum Travel Speeds		Optimum Travel Speeds	
			Inches	mm	IPM	mm/min	IPM	mm/min
60	135	0	1/16"	1.6	666	16916	433	10995
	138	0.25	1/8"	3.2	400	10160	260	6604
	141		1/4"	6.4	145	3683	94	2388
	146	0.75	3/8"	9.5	74	1880	48	1219
	149	*	1/2"	12.7	51	1295	30	762
	153		5/8"	15.9	33	838	21	545

* Piercing material in this range is not recommended, it will shorten consumable life. Starting cuts at the edge of the metal is recommended.

Maximum travel speeds are the fastest travel speeds possible to cut the material without regard to cut quality. Optimum travel speeds provide the best cut angle, least dross and best cut surface finish. **Remember that cut charts are intended to provide a good starting point for each different cut assignment.** Every cutting system requires "fine tuning" for each cutting application in order to obtain the desired cut quality.

40 Amp Mechanized Shielded Consumables

- Torch-to-work distance for the following cut chart is 1/16 inch (1.5 mm) for all cuts.

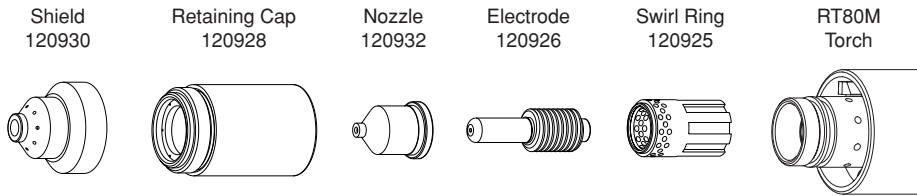

Mild Steel

Arc Current	Arc Voltage	Motion Delay	Material Thickness		Maximum Travel Speeds		Optimum Travel Speeds	
			Inches	mm	IPM	mm/min	IPM	mm/min
25	147	0	26 GA	0.5	638	16205	415	10541
	148		22 GA	0.8	500	12700	325	8255
	149		18 GA	1.3	312	7925	203	5156
	152		16 GA	1.5	176	4470	114	2896
40	144	0.25	14 GA	1.9	640	16256	221	5613
	146	0.50	10 GA	3.4	151	3835	98	2489
	147	0.75	3/16	4.7	97	2464	63	1600
	149	1.00	1/4	6.4	74	1880	48	1219

Stainless

Arc Current	Arc Voltage	Motion Delay	Material Thickness		Maximum Travel Speeds		Optimum Travel Speeds	
			Inches	mm	IPM	mm/min	IPM	mm/min
25	139	0	26 GA	0.5	631	16027	410	10414
	139		22 GA	0.8	496	12598	322	8179
40	142	0.25	18 GA	1.3	592	15037	335	8509
	144		16 GA	1.5	374	9500	243	6172
	144		14 GA	1.9	221	5613	144	3658
	147	0.50	10 GA	3.4	107	2718	70	1778
	149	0.75	3/16	4.7	67	1702	44	1118
	149	1.00	1/4	6.4	47	1194	31	787

Aluminum

Arc Current	Arc Voltage	Motion Delay	Material Thickness		Maximum Travel Speeds		Optimum Travel Speeds	
			Inches	mm	IPM	mm/min	IPM	mm/min
25	150	0	1/32	0.8	610	15494	397	10084
	152		1/16	1.5	268	6807	174	4420
40	146	0.25	3/32	2.4	293	7442	190	4826
	149	0.50	1/8	3.2	204	5182	133	3378
	151	1.00	1/4	6.4	76	1930	49	1245

Maximum travel speeds are the fastest travel speeds possible to cut the material without regard to cut quality. Optimum travel speeds provide the best cut angle, least dross and best cut surface finish. **Remember that cut charts are intended to provide a good starting point for each different cut assignment.** Every cutting system requires “fine tuning” for each cutting application in order to obtain the desired cut quality.

OPERATION

40 Amp Unshielded Consumables

- Torch-to-work distance for the following cut chart is 1/16 inch (1.5 mm) for all cuts.

Deflector
120979



Retaining Cap
120928

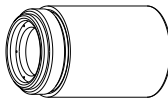

Nozzle
220006



Electrode
120926



Swirl Ring
120925

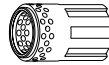

RT80M
Torch

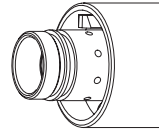

Mild Steel

Arc Current	Arc Voltage	Motion Delay	Material Thickness		Maximum Travel Speeds		Optimum Travel Speeds	
			Inche s	mm	IPM	mm/min	IPM	mm/min
25	125	0	26 GA	0.5	550	13970	353	8966
	128		22 GA	0.8	484	12294	315	8001
	130		18 GA	1.3	238	6045	155	3937
	131		16 GA	1.5	167	4242	109	2769
40	129	0.25	14 GA	1.9	326	8280	212	5385

Stainless

Arc Current	Arc Voltage	Motion Delay	Material Thickness		Maximum Travel Speeds		Optimum Travel Speeds	
			Inche s	mm	IPM	mm/min	IPM	mm/min
25	127	0	26 GA	0.5	561	14249	365	9271
	127		22 GA	0.8	453	11506	295	7493
40	123	0.25	18 GA	1.3	500	12700	325	8255
	127		16 GA	1.5	367	9322	239	6071
	128		14 GA	1.9	220	5588	143	3632

Aluminum

Arc Current	Arc Voltage	Motion Delay	Material Thickness		Maximum Travel Speeds		Optimum Travel Speeds	
			Inche s	mm	IPM	mm/min	IPM	mm/min
25	125	0	1/32	0.8	564	14326	366	9296
	127		1/16	1.5	236	5994	153	3886
40	127	0.25	3/32	2.4	261	6629	170	4318



Maximum travel speeds are the fastest travel speeds possible to cut the material without regard to cut quality. Optimum travel speeds provide the best cut angle, least dross and best cut surface finish. **Remember that cut charts are intended to provide a good starting point for each different cut assignment.** Every cutting system requires "fine tuning" for each cutting application in order to obtain the desired cut quality.







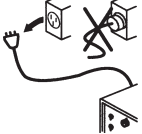

MAINTENANCE AND PARTS

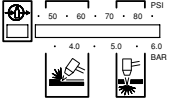
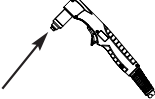
In this section:

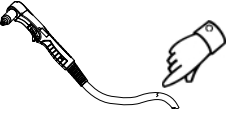
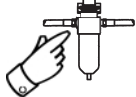

Routine Maintenance	5-2
Inspect Consumables.....	5-3
Parts	5-4
Torch Consumable Configurations	5-4
RT80 Hand Torch Assembly.....	5-6
RT80M Machine Torch Assembly.....	5-8
Accessories.....	5-10

Routine Maintenance

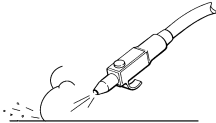
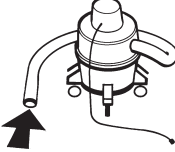
		<p>WARNING ELECTRIC SHOCK CAN KILL</p>
 <p>Disconnect electrical power before performing any maintenance. See <i>Section 1</i> of the Operator Manual for additional safety precautions.</p>		

 Each Use	 Check gas pressure.	 Check consumables for wear and proper installation.
 Each Week		Check torch cap-on safety switch: observe that red fault LED and yellow torch cap LED illuminate when cap is loosened.
 3 Months	 Replace damaged labels.	 Check trigger for damage. Check torch body for cracks or exposed wires.
 Replace damaged power cord or plug.	 Replace damaged torch lead.	 Check pressure hose, filter element, and connections for leaks.
 6 Months		 Clean the inside of the power supply with air pressure or vacuum.

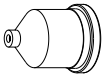
Inspect Consumables

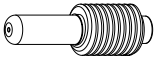
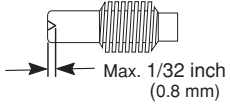
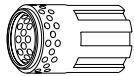
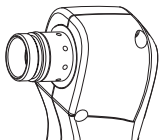
<i>Part</i>	<i>Check For</i>	<i>Action</i>
 <p>Nozzle Center hole</p>	<p>Roundness of through hole</p>  <p>Good Worn</p>	<p>Replace</p>
 <p>Electrode Center surface</p>	 <p>Max. 1/32 inch (0.8 mm)</p> <p>Maximum pit depth 1/32 inch (0.8 mm)</p>	<p>Replace</p>
 <p>Swirl Ring External surfaces Central bore (I.D.) Gas holes</p>	<p>Damage or debris</p> <p>Does electrode slide easily?</p> <p>Blocked holes</p>	<p>Replace</p> <p>Replace</p> <p>Replace</p>
 <p>Torch O-ring External surfaces</p>	<p>Damage or wear</p> <p>Dry surface</p>	<p>Replace</p> <p>Apply a thin film of Hypertherm grease (Part No. 027055)</p>

Torch Consumable Configurations

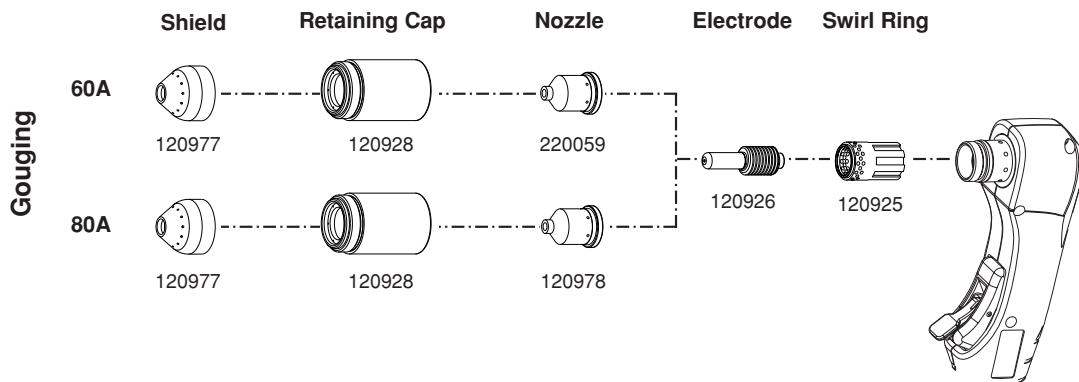
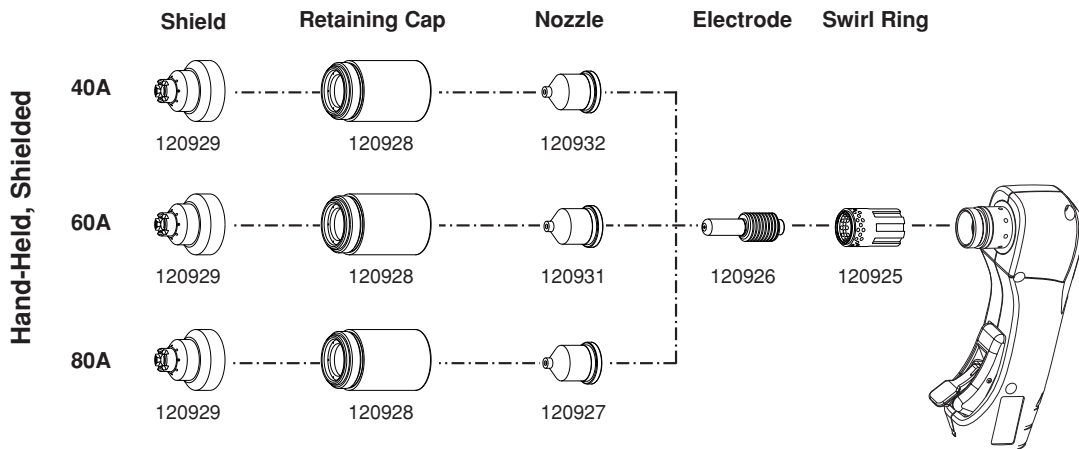

Torch Consumable Configurations

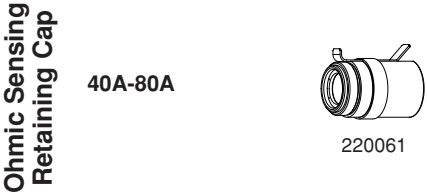
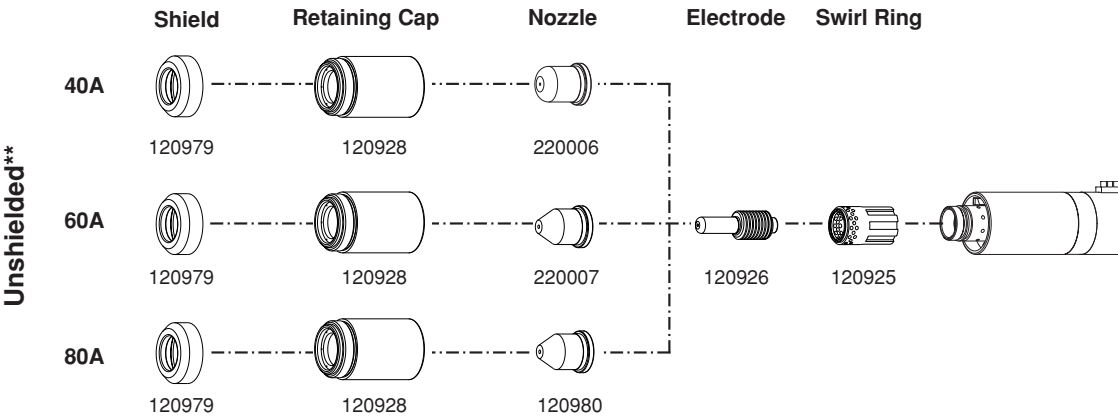
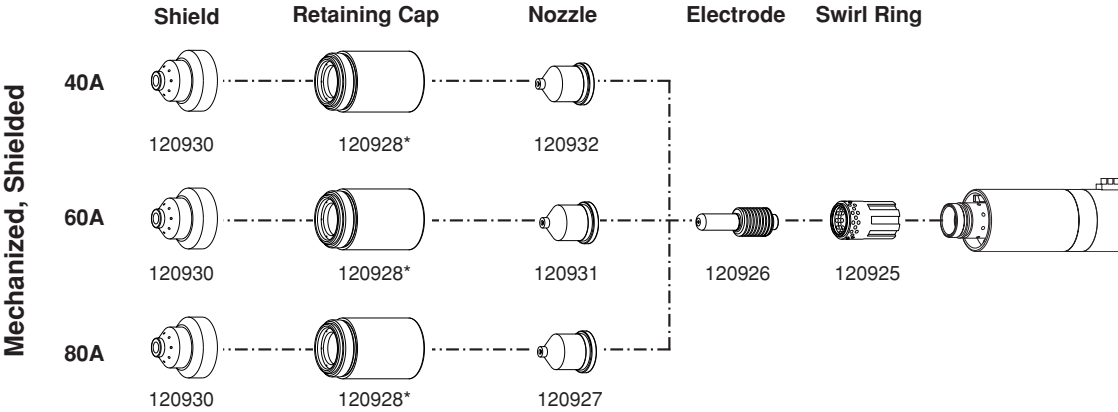

* Use an ohmic sensing cap when a compatible torch height controller is installed.

** In CE countries, unshielded consumables may only be used in mechanized torch applications.

Maintain torch-to-work distance of approximately 1/8 inch (3mm).

MAINTENANCE AND PARTS

RT80 Hand Torch Assembly

Item	Part Number	Description	Quantity
	087033*	RT80 Hand Torch Assembly with 25 ft (7.6 m) Lead	
	087034*	RT80 Hand Torch Assembly with 50 ft (15.2 m) Lead	
1	128564	Torch Main Body Replacement	1
2	027889	Retaining Clip	1
3	058519	O-ring	1
4	128639	Cap-on Sensor Replacement	1
5	075571	Cap-on Sensor screws	2
6	128521	Torch Head Repair Kit	1
7	128644	Handle Kit	1
8	075586	Handle screws	5
9	002244	Safety Trigger	1
10	027254	Spring	1
11	128829	25 ft (7.6 m) Torch Lead Replacement	1
12	128830	50 ft (15.2 m) Torch Lead Replacement	1
13	128826	RT80/RT80M Quick Disconnect Repair Kit	1
14	128642	Start Switch	1

* Top assembly includes the following consumables (See page 6 for details of consumable parts):

120926	Electrode	1
120925	Swirl Ring	1
120928	Retaining Cap	1
120929	Shield	1
120927	Nozzle	1

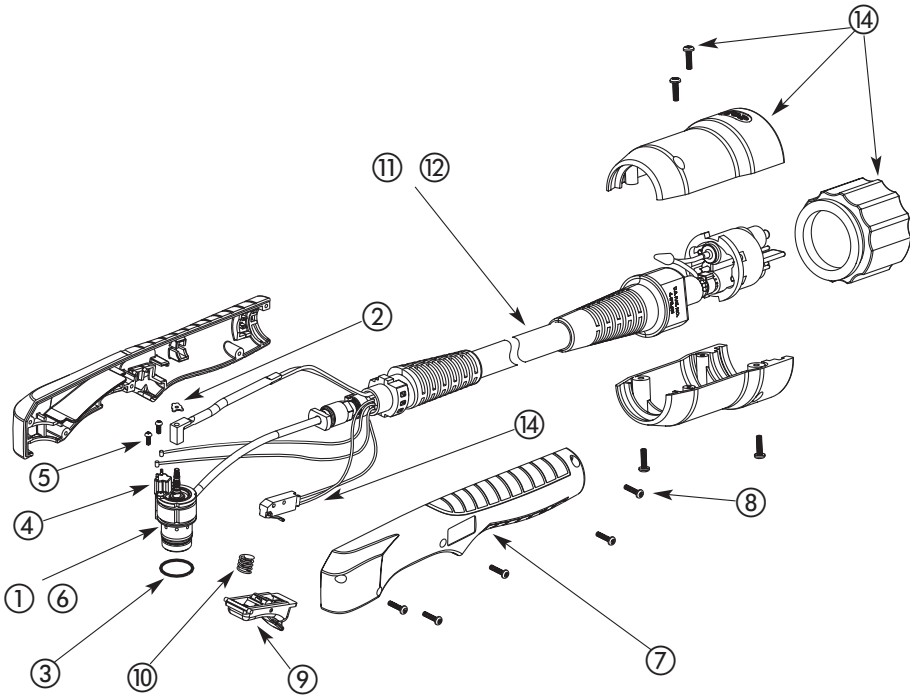

MAINTENANCE AND PARTS

RT80M Machine Torch Assembly

Item	Part Number	Description	Quantity
	087035*	RT80M Machine Torch Assembly with 25 ft (7.6 m) Lead	
	087036*	RT80M Machine Torch Assembly with 50 ft (15.2 m) Lead	
1	128640	Torch Main Body Replacement Kit	1
2	027889	Retaining Clip	1
3	058519	O-ring	1
4	128639	Cap-on Sensor Replacement Kit	1
5	075571	Cap-on Sensor Screws	2
6	128521	Torch Head Repair Kit	1
7	128643	Torch Mounting Sleeve Replacement Kit	1
8	075618	Torch Mounting Screws	3
9	128710	Torch Positioning Sleeve	1
10	128827	25 ft (7.6 m) Torch Lead Replacement Kit	1
11	128828	50 ft (15.2 m) Torch Lead Replacement Kit	1
12	128826	RT80/RT80M Quick Disconnect Repair Kit	1
	128645	Torch Mounting Kit (for reassembly after installation)	1

* Top assembly includes the following consumables (See page 6 for details of consumable parts):

120926	Electrode	1
120925	Swirl Ring	1
120928	Retaining Cap	1
120929	Shield	1
120927	Nozzle	1

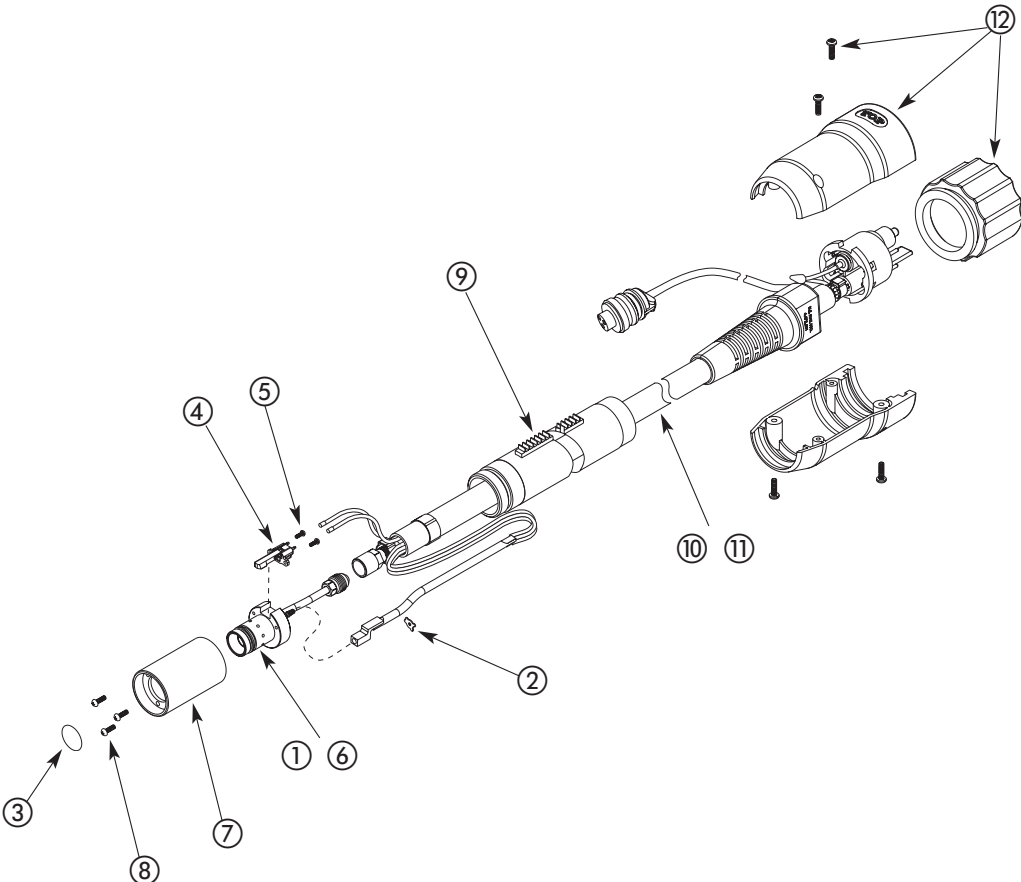

Accessories

028714	On/Off Pendant with Lead, 25 ft (7.6 m)
128061	On/Off Pendant with Lead, 50 ft (15.2 m)
128062	On/Off Pendant with Lead, 75 ft (23 m)
027668	Circle Cutting Guide Assembly
027684	Replacement Bushing for Circle Cutting Guide Assembly
220049	Hand Heat Shield, Gouging